

PolarHV™ Power MOSFET

N-Channel Enhancement Mode
Fast Recovery Diode
Avalanche Rated

IXFH26N60P
IXFT26N60P
IXFV26N60P
IXFV26N60PS

$V_{DSS} = 600 \text{ V}$
 $I_{D25} = 26 \text{ A}$
 $R_{DS(on)} \leq 270 \text{ m}\Omega$
 $t_{rr} \leq 200 \text{ ns}$

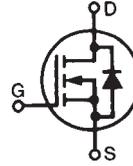

Symbol	Test Conditions	Maximum Ratings	
V_{DSS}	$T_J = 25^\circ\text{C}$ to 150°C	600	V
V_{DGR}	$T_J = 25^\circ\text{C}$ to 150°C ; $R_{GS} = 1 \text{ M}\Omega$	600	V
V_{GSS}	Continuous	± 30	V
V_{GSM}	Transient	± 40	V
I_{D25}	$T_C = 25^\circ\text{C}$	26	A
I_{DM}	$T_C = 25^\circ\text{C}$, pulse width limited by T_{JM}	65	A
I_{AR}	$T_C = 25^\circ\text{C}$	13	A
E_{AR}	$T_C = 25^\circ\text{C}$	40	mJ
E_{AS}	$T_C = 25^\circ\text{C}$	1.2	J
dv/dt	$I_S \leq I_{DM}$, $di/dt \leq 100 \text{ A}/\mu\text{s}$, $V_{DD} \leq V_{DSS}$ $T_J \leq 150^\circ\text{C}$, $R_G = 5 \Omega$	10	V/ns
P_D	$T_C = 25^\circ\text{C}$	460	W
T_J		-55 ... +150	$^\circ\text{C}$
T_{JM}		150	$^\circ\text{C}$
T_{stg}		-55 ... +150	$^\circ\text{C}$
T_L	1.6 mm (0.062 in.) from case for 10 s	300	$^\circ\text{C}$
T_{SOLD}	Plastic body for 10 s	260	$^\circ\text{C}$
M_d	Mounting torque (TO-3P&TO-247)	1.13/10	Nm/lb.in.
F_c	Mounting force (PLUS220)	11..65/2.5..15	N/lb
Weight	TO-247	6.0	g
	TO-268	5.0	g
	PLUS220 & PLUS220SMD	4.0	g

TO-247 (IXFH)

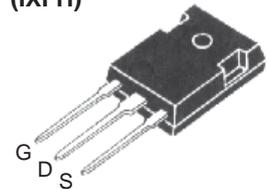

TO-268 (IXFT)

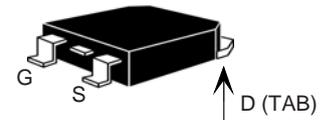

PLUS220 (IXFV)

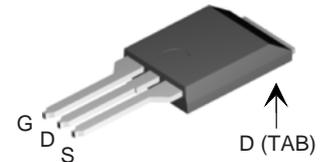

PLUS220SMD (IXFV...S)

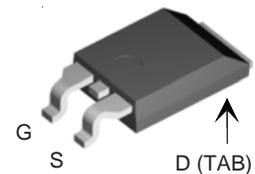

G = Gate D = Drain
S = Source TAB = Drain

Symbol	Test Conditions ($T_J = 25^\circ\text{C}$, unless otherwise specified)	Characteristic Values		
		Min.	Typ.	Max.
BV_{DSS}	$V_{GS} = 0 \text{ V}$, $I_D = 250 \mu\text{A}$	600		V
$V_{GS(th)}$	$V_{DS} = V_{GS}$, $I_D = 4 \text{ mA}$	2.5		V
I_{GSS}	$V_{GS} = \pm 30 \text{ V}$, $V_{DS} = 0 \text{ V}$			$\pm 100 \text{ nA}$
I_{DSS}	$V_{DS} = V_{DSS}$ $V_{GS} = 0 \text{ V}$ $T_J = 125^\circ\text{C}$			25 μA
				250 μA
$R_{DS(on)}$	$V_{GS} = 10 \text{ V}$, $I_D = 0.5 I_{D25}$ Pulse test, $t \leq 300 \mu\text{s}$, duty cycle $d \leq 2 \%$			270 $\text{m}\Omega$

Features

- Fast Recovery diode
- Unclamped Inductive Switching (UIS) rated
- International standard packages
- Low package inductance
- easy to drive and to protect

Advantages

- Easy to mount
- Space savings
- High power density

Symbol	Test Conditions	Characteristic Values ($T_J = 25^\circ\text{C}$, unless otherwise specified)		
		Min.	Typ.	Max.
g_{fs}	$V_{DS} = 20\text{ V}; I_D = 0.5 I_{D25}$, pulse test	16	26	S
C_{iss}	$V_{GS} = 0\text{ V}, V_{DS} = 25\text{ V}, f = 1\text{ MHz}$		4150	pF
C_{oss}			400	pF
C_{rss}			27	pF
$t_{d(on)}$	$V_{GS} = 10\text{ V}, V_{DS} = 0.5 I_{D25}$ $R_G = 5\ \Omega$ (External)		25	ns
t_r			27	ns
$t_{d(off)}$			75	ns
t_f			21	ns
$Q_{g(on)}$	$V_{GS} = 10\text{ V}, V_{DS} = 0.5 V_{DSS}, I_D = 0.5 I_{D25}$		72	nC
Q_{gs}			27	nC
Q_{gd}			24	nC
R_{thJC}				0.27 $^\circ\text{C/W}$
R_{thCs}	(PLUS220 & TO-247)		0.21	$^\circ\text{C/W}$

Symbol	Test Conditions	Characteristic Values ($T_J = 25^\circ\text{C}$, unless otherwise specified)		
		Min.	Typ.	Max.
I_s	$V_{GS} = 0\text{ V}$			26 A
I_{SM}	Repetitive			78 A
V_{SD}	$I_F = I_s, V_{GS} = 0\text{ V}$, pulse test			1.5 V
t_{rr}	$I_F = 25\text{ A}, -di/dt = 100\text{ A}/\mu\text{s}$ $V_R = 100\text{ V}; V_{GS} = 0\text{ V}$		150	200 ns
I_{RM}			7	A
Q_{RM}			0.7	μC

Characteristic Curves

Fig. 1. Output Characteristics
@ 25°C

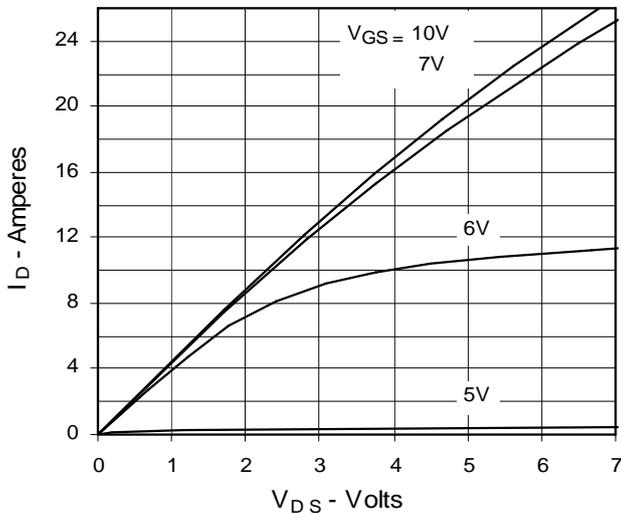
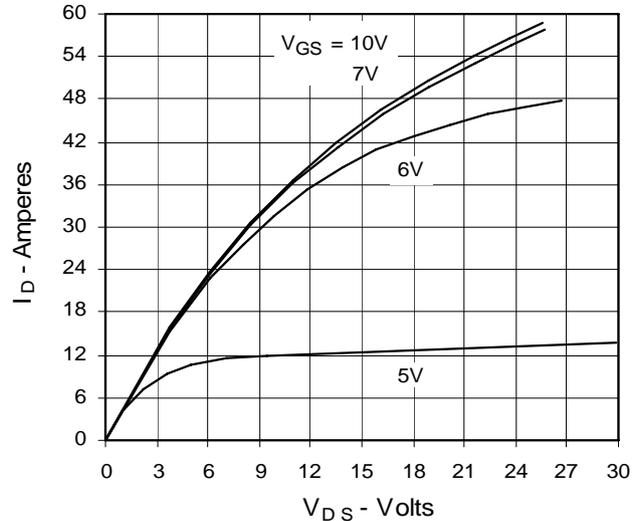

Fig. 2. Extended Output Characteristics
@ 25°C



IXYS reserves the right to change limits, test conditions, and dimensions.

IXYS MOSFETs and IGBTs are covered by 4,835,592 4,931,844 5,049,961 5,237,481 6,162,665 6,404,065 B1 6,683,344 6,727,585
 one or more of the following U.S. patents: 4,850,072 5,017,508 5,063,307 5,381,025 6,259,123 B1 6,534,343 6,710,405 B2 6,759,692
 4,881,106 5,034,796 5,187,117 5,486,715 6,306,728 B1 6,583,505 6,710,463 6,771,478 B2

Fig. 3. Output Characteristics @ 125°C

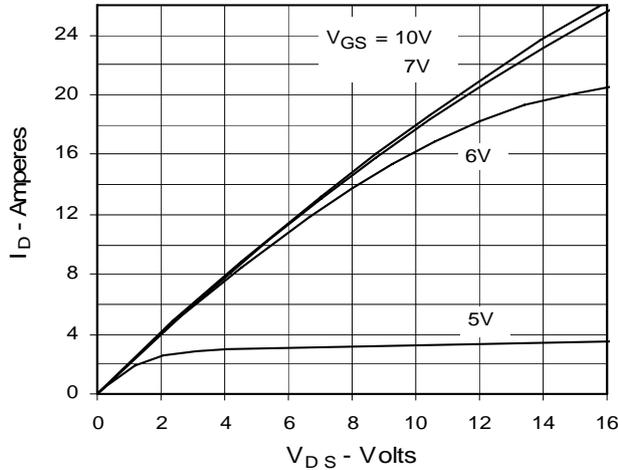

Fig. 4. $R_{DS(on)}$ Normalized to 0.5 I_{D25} Value vs. Junction Temperature

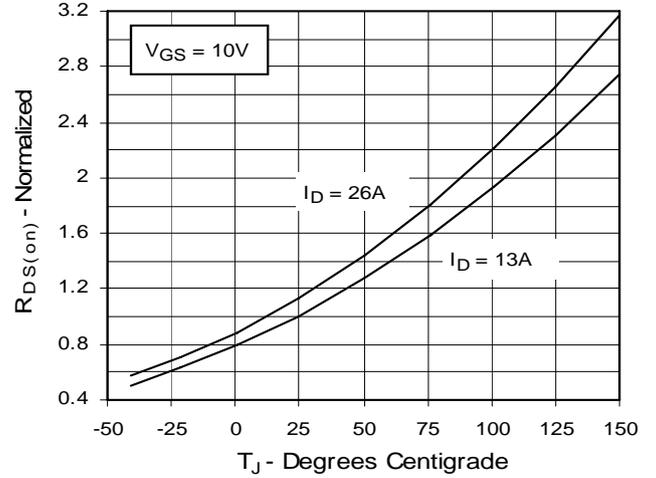

Fig. 5. $R_{DS(on)}$ Normalized to 0.5 I_{D25} Value vs. I_D

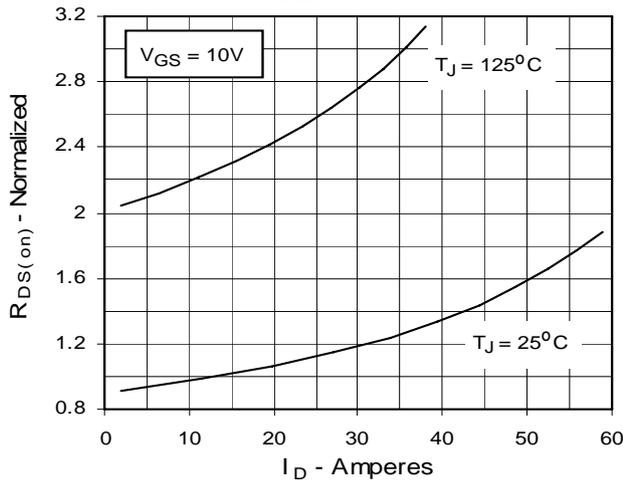

Fig. 6. Drain Current vs. Case Temperature

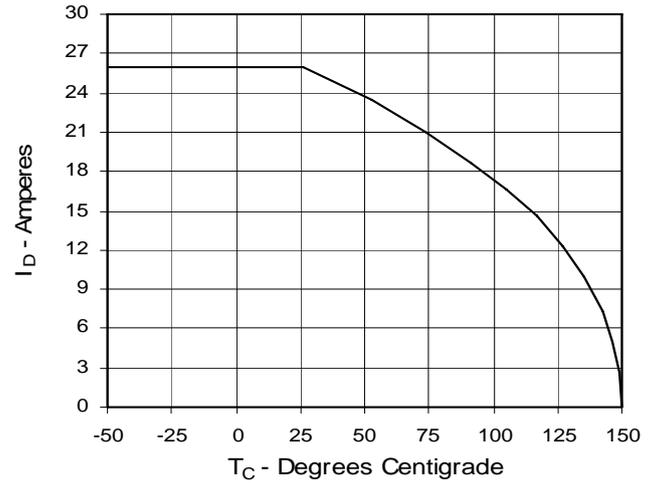

Fig. 7. Input Admittance

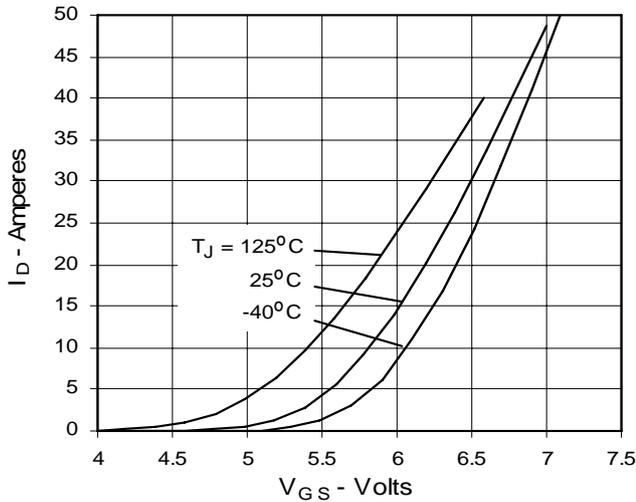

Fig. 8. Transconductance

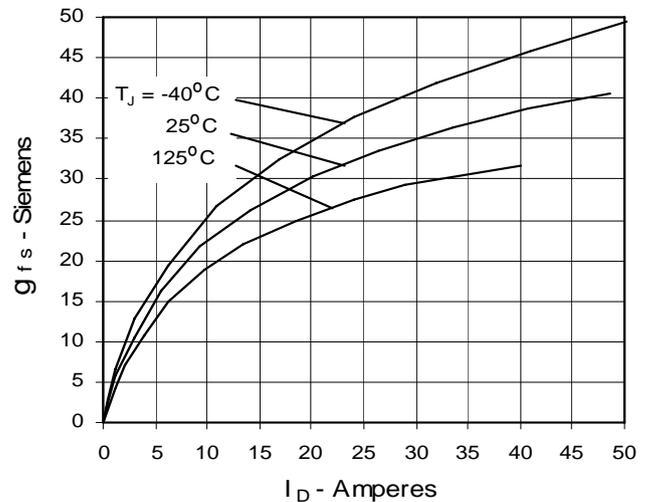

Fig. 9. Source Current vs. Source-To-Drain Voltage

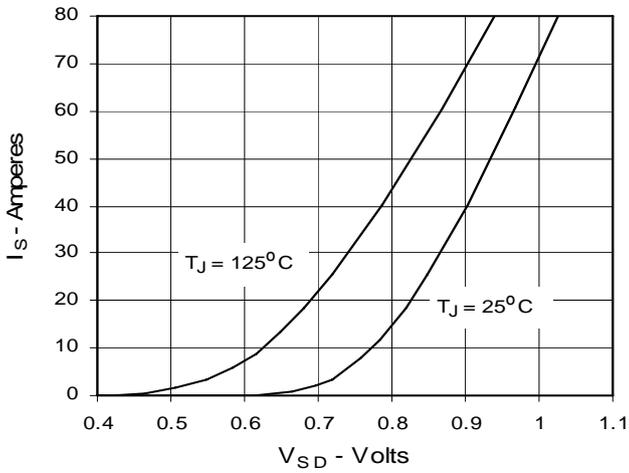

Fig. 10. Gate Charge

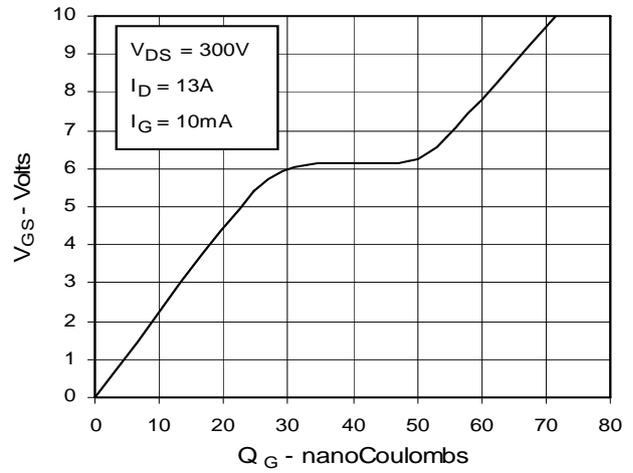

Fig. 11. Capacitance

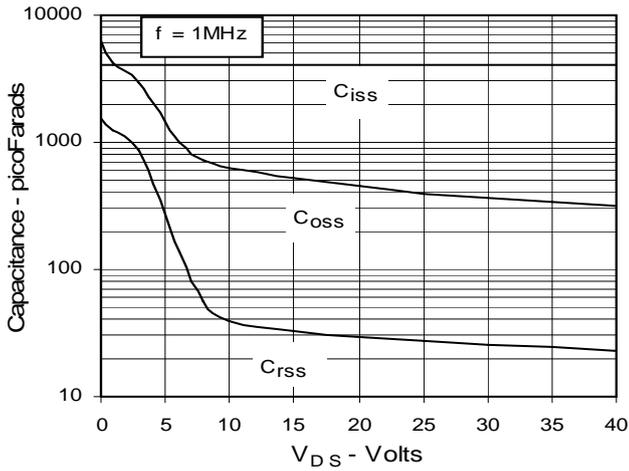
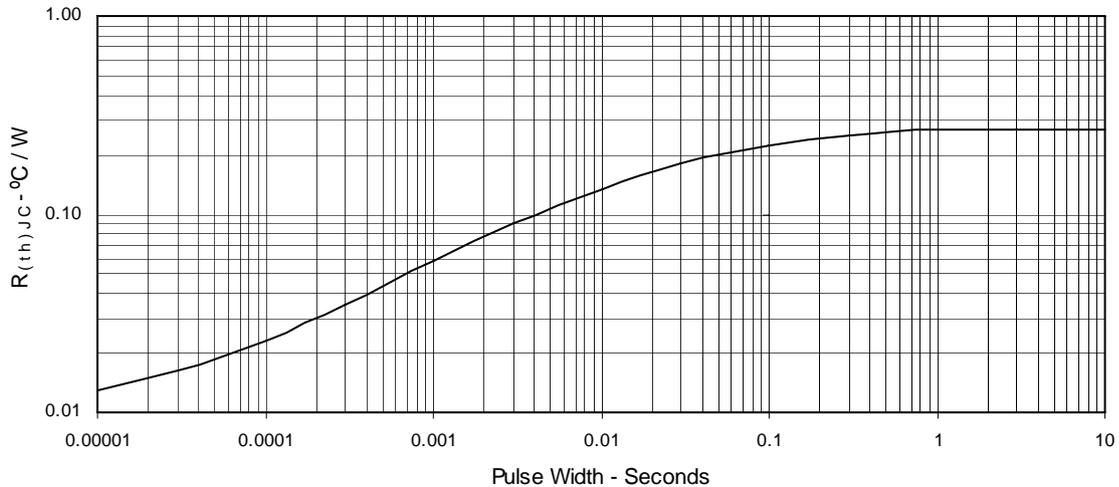
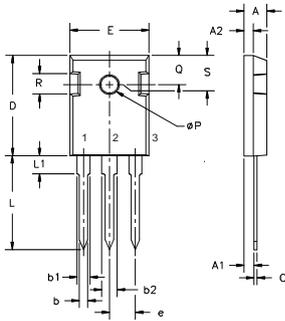

Fig. 12. Maximum Transient Thermal Resistance



TO-247 AD (IXFH) Outline



Dim.	Millimeter		Inches	
	Min.	Max.	Min.	Max.
A	4.7	5.3	.185	.209
A ₁	2.2	2.54	.087	.102
A ₂	2.2	2.6	.059	.098
b	1.0	1.4	.040	.055
b ₁	1.65	2.13	.065	.084
b ₂	2.87	3.12	.113	.123
C	.4	.8	.016	.031
D	20.80	21.46	.819	.845
E	15.75	16.26	.610	.640
e	5.20	5.72	0.205	0.225
L	19.81	20.32	.780	.800
L1		4.50		.177
∅P	3.55	3.65	.140	.144
Q	5.89	6.40	0.232	0.252
R	4.32	5.49	.170	.216
S	6.15 BSC		242 BSC	

TO-268 (IXFT) Outline

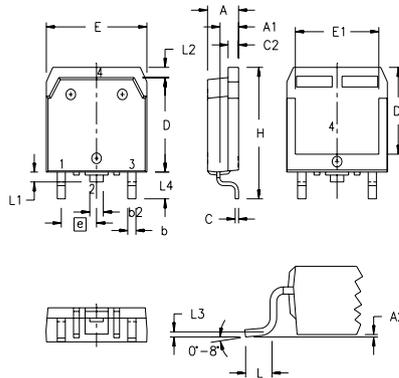

SYM	INCHES		MILLIMETERS	
	MIN	MAX	MIN	MAX
A	.193	.201	4.90	5.10
A ₁	.106	.114	2.70	2.90
A ₂	.001	.010	0.02	0.25
b	.045	.057	1.15	1.45
b ₂	.075	.083	1.90	2.10
C	.016	.026	0.40	0.65
C ₂	.057	.063	1.45	1.60
D	.543	.551	13.80	14.00
D ₁	.488	.500	12.40	12.70
E	.624	.632	15.85	16.05
E ₁	.524	.535	13.30	13.60
e	.215 BSC		5.45 BSC	
H	.736	.752	18.70	19.10
L	.094	.106	2.40	2.70
L ₁	.047	.055	1.20	1.40
L ₂	.039	.045	1.00	1.15
L ₃	.010 BSC		0.25 BSC	
L ₄	.150	.161	3.80	4.10

PLUS220 (IXFV) Outline

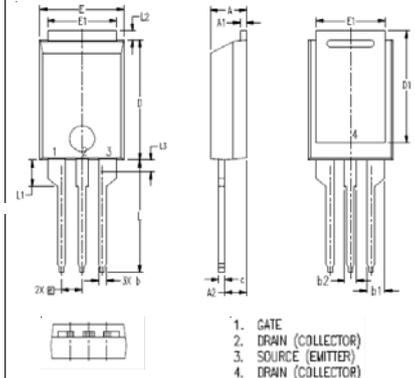

SYM	INCHES		MILLIMETER	
	MIN	MAX	MIN	MAX
A	.169	.185	4.30	4.70
A ₁	.028	.035	0.70	0.90
A ₂	.098	.118	2.50	3.00
b	.035	.047	0.90	1.20
b ₁	.080	.095	2.03	2.41
b ₂	.054	.064	1.37	1.63
c	.028	.035	0.70	0.90
D	.551	.591	14.00	15.00
D ₁	.512	.539	13.00	13.70
E	.394	.433	10.00	11.00
E ₁	.331	.346	8.40	8.80
e	.100 BSC		2.54 BSC	
L	.512	.551	13.00	14.00
L ₁	.118	.138	3.00	3.50
L ₂	.035	.051	0.90	1.30
L ₃	.047	.059	1.20	1.50

1. GATE
2. DRAIN (COLLECTOR)
3. SOURCE (EMITTER)
4. DRAIN (COLLECTOR)

PLUS220SMD (IXFV_S) Outline

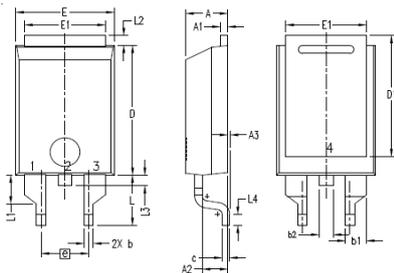

SYM	INCHES		MILLIMETER	
	MIN	MAX	MIN	MAX
A	.169	.185	4.30	4.70
A ₁	.028	.035	0.70	0.90
A ₂	.098	.118	2.50	3.00
A ₃	.000	.010	0.00	0.25
b	.035	.047	0.90	1.20
b ₁	.080	.095	2.03	2.41
b ₂	.054	.064	1.37	1.63
c	.028	.035	0.70	0.90
D	.551	.591	14.00	15.00
D ₁	.512	.539	13.00	13.70
E	.394	.433	10.00	11.00
E ₁	.331	.346	8.40	8.80
e	.200 BSC		5.08 BSC	
L	.209	.228	5.30	5.80
L ₁	.118	.138	3.00	3.50
L ₂	.035	.051	0.90	1.30
L ₃	.047	.059	1.20	1.50
L ₄	.039	.059	1.00	1.50

1. GATE
2. DRAIN (COLLECTOR)
3. SOURCE (EMITTER)
4. DRAIN (COLLECTOR)